



TX7008

8 Loop Intelligent Addressable Fire Alarm Control Panel

Features and Benefits

- Compliance EN54-2 and EN54-4
- Using advance microprocessor technology with Large memory capacity
- Built-in USB port for commissioning purpose
- Enhance user interface combining LCD Touch screen and keypad access
- Support real time visual algorithm
- Enhance false alarm prevention
- Keypad and PC programming
- Built-in Multiple interface protocol such as USB/Ethernet/CanBus/ Serial/RS485 (Available only in TX7004/4 Panel)
- Support Loop Powered devices for extra saving on cable cost
- Built-In Printer and 160 LED Zones Indicators

System Capacity

- Maximum 8 loop in network application
- Support 254 Devices (1,524 ideal)
- Network up to 512 Node
- Programmable Capacity
- Zones up to 3000
- Sounders Groups 1-1000
- Modules Groups 1001- 2000
- Built-in 160 LED Zones Indicator

Overview

The TX7008 comprise of a range of analogue addressable, microprocessor-based fire alarm control equipment to offer flexibility in both design and operation. The System is modular concept for easy tailoring of system design, to meet the full requirements of the project. The TX7008 Intelligent Fire Alarm Control Panel is designed and manufactured to meet the requirement of BS EN54 Part 2&4.

The TX7008 is designed to provide early warning fire detection, to quickly identify the location of fire and provide user definable text informing the occupants of the building of potential smoke spread. Simultaneously, the TX7008 will alert and evacuate the occupants, and control all necessary auxiliary command functions such as elevator control, air handling shut down, gas shut off & damper control, as per the cause and effects requirements configured though Command Builder Set-up.

Commissioning Advantage

- Auto Enrolling of Devices
- Loop Mapping with colour coding status
- Monitor device mismatch and dual address conflict
- Command Builder to create requirements for fire event scenario
- With Loop protection against power surge
- One-man test with On/Off sounder Programming Protection

Technical Specification

Compliance	EN54-2:1997 +A1:2006, EN54-4:1997 + A1:2002 + A2:2006
Power Rating	
Input Voltage	240VAC +10%-15%, 50/60Hz
Input Current Consumption	1.3 A
PSU Output to CIE	21.5 to 28.5 VDC
Batteries	2 x 12V / 45AH (Rechargeable-Lead acid type battery)
Networking and Interfaces	
Panel to panel communication	Can Bus [loop]
Number of Panels	512
Interface Card	USB, Optional: RS485 Serial, RS232 Serial, Ethernet
System Capacity	
Memory [Non-Volatile]	1000 Fire Events, 10,000 General Event
Zones	3,000 programmable
Total Group	3,000 programmable
Sounder Group	1,000 programmable
Common Group	2,000 programmable

Loop Specifications	
Protocol/ Addressing	T&A, Value range from 1 to 254
No. of Loop	6-to-8 Loop
Protection	Built-in 4kV Surge protection
Power rating	16 to 24Vdc / 120mA
Cabling	1.0Km Max Length/2 x 1.5mm ² solid core Fire resistance
Input/outputs	
Programmable Relays	4 circuits: Normally Open/Close
Programmable Input	1 Circuit: Power limited 24Vdc (for future use)
Programmable Auxiliary Power	19 to 28 VDC (Note: Current Limited)
Fixed Outputs (FPE/Sounder)	2 Circuits: 18 to 28 VDC (Note: Current Limited)
Indicator	24 LED Status/ 160 Zone Indicators
Display	7" TFT Touch Screen
Keypad	5 Brigade buttons and Programming Keypad
Material / Color	Flat sheet Metal / with outer glass door, Orange stripe
Dimension Lx W x H	550 mm x 510 mm x 222 mm
Weight	23 Kgs
Humidity	0 to 95% Relative Humidity, Non condensing

Cabinet Details

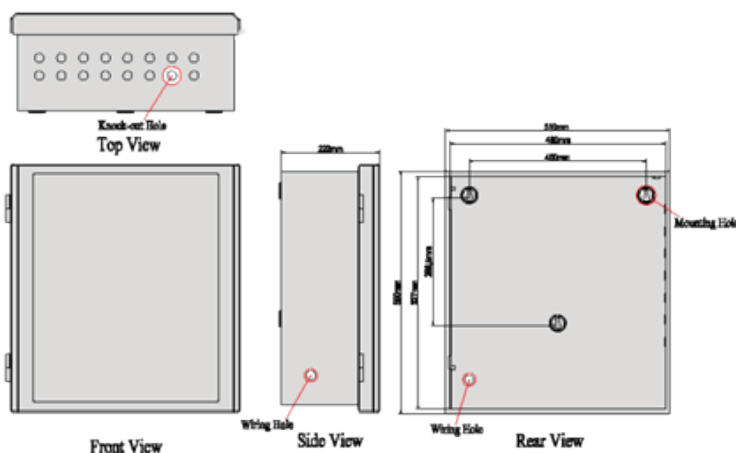



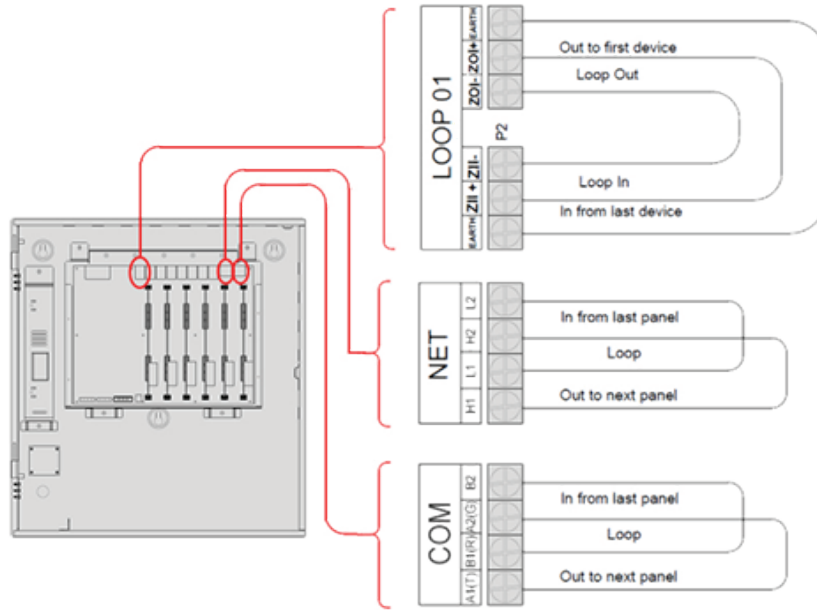

Loop and Network Wiring Details

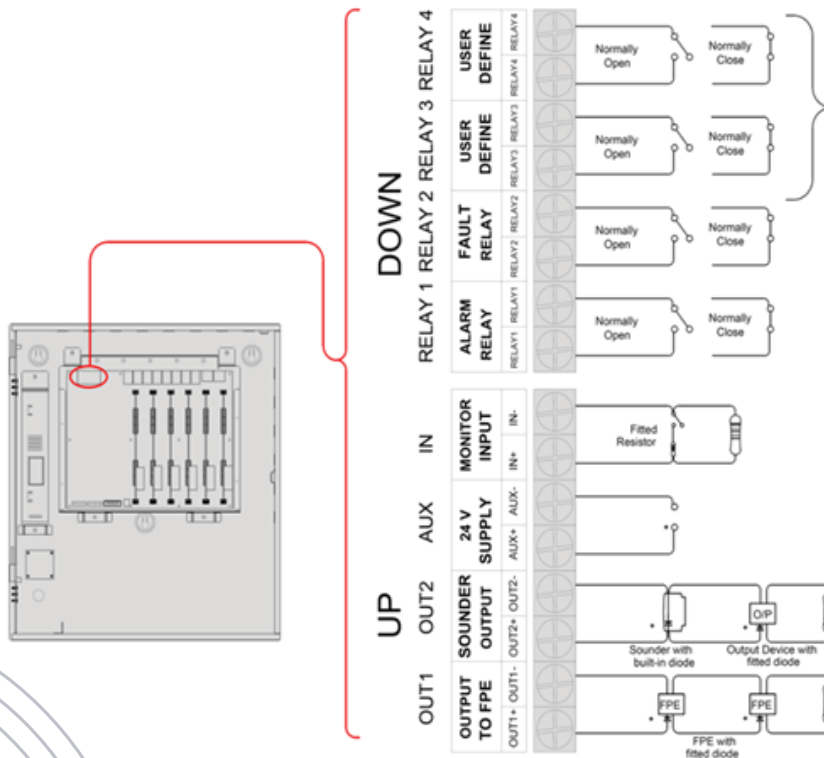

Input/output Wiring Details



Ordering Information

Part Number	Image	System	Description
TX7008		Intelligent Addressable Fire Alarm Control Panel	Wall-mount. Fitted 4 loop card, up to 2032 addressable devices. Built-in Communication Card. Built-in 160 LED Zones Indicator. Ideal for Network Repeater Panel application. 550 mm x 510 mm x 222 mm Cabinet Size. Excluding Batteries. Optional Accessories: TX7814
TX7008-6		Intelligent Addressable Fire Alarm Control Panel	Wall-mount. Fitted 3 loop card, up to 1524 addressable devices. Built-in Communication Card. Built-in 160 LED Zones Indicator. Ideal for Network Repeater Panel application. 550 mm x 510 mm x 222 mm Cabinet Size. Excluding Batteries. Optional Accessories: LC7008 , TX7814
LC7008		Dual Loop Card	Dual Loop Card for TX7008, capacity of 508 devices.
NC7008		Network card	CANBUS Network connection. Communication cable for connecting with up to 512 network FACP.
TX7814		Dongle for TX7	USB Dongle Access control of TX7 panel series.